

YDS-USB-1018 V1**2MP 1018 OmniVision OV2710 M12 Fixed Focus Dual Lens Stereo
USB 2.0 Camera Module**

YDS-USB-1018 V1 is a Dual Lens Stereo Type 2MP Fixed Focus USB camera module based on 1/2.7" OV2710 (color) and OV2710 (monochrome) image sensors. It delivers high-speed, 2K resolution ultra sharp image in RGB (Color) and IR (Black and White). The S-mount (M12) lens holder enables customers to choose different lens as per varies applications. This camera module is ideal solution for face recognition, identity detection, access control.

Key Features

- 2K resolution (1920 x 1080) OmniVision OV2710 Color sensor
- 2K resolution (1920 x 1080) OmniVision OV2710 Black and White sensor
- Dual lens stereo cameras (Color and Black/White)
- High speed USB 2.0 Plug and Play
- MJPG and YUV2 output format
- Low power consumption
- Compact size
- UVC compliant to Windows, Linux, OS with UVC driver
- USB OTG (On-The-Go) support

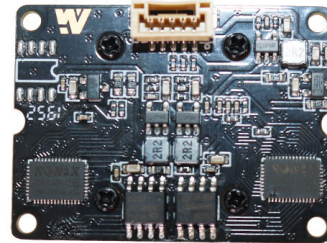
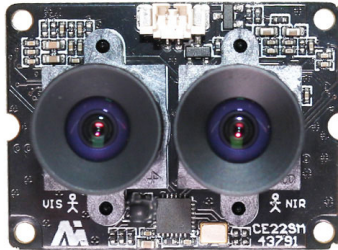

YDS CAMERA MODULE

your best camera partner

YDS-USB-1018 V1

2MP OV2710 M12 Fixed Focus LED Dual Lens Stereo USB 2.0 Camera Module

Camera Module No.	YDS-USB-1018 V1
Resolution	2MP
Image Sensor	OV2710 (Color) / OV2710 (IR)
Sensor Type	1/2.7"
Pixel Size	3.0 um x 3.0 um
EFL	3.00 mm
F.NO	2.50
Pixel	1920 x 1080
View Angle	89°(DFOV) 76°(HFOV) 60°(VFOV)
Lens Dimensions	14.00 x 14.00 x 17.00 mm
Module Type	Fixed Focus
Lens Model	YDS-LENS-1018 V1
Interface	USB 2.0
Output Format	MJPEG / YUV2
Auto Control	Saturation, Contrast, Acutance White Balance, Exposure
Audio	None
Input Voltage	DC 5V
Working Current	Max 500mA
PCB Size	38 x 28 mm
System Compatibility	Windows XP (SP2, SP3), Vista, 7, 8, 10, 11 Android, Mac OS, Linux or OS with UVC Driver Raspberry Pi by USB Port
Software for USB Camera	AMCAP, Webcam Viewer, V4L2 Controls Contacam, VLC Player, MotionEye OS iSpy, ZoneMider, Yawcam
Lens Type	650nm IR Cut / 850nm IR Pass
Operating Temperature	-30°C to +85°C
USB Cable	YDS-Cable-U023

Wide Compatibility with Windows, Android, Mac OS, Linux, or Raspberry Pi



Windows®



Android



Mac OS



Linux



Raspberry Pi

www.YDSCAM.com sales@ydscam.com Phone (WeChat, QQ): (+86) 177 2732 6718

All rights reserved @ YingDeShun Co. Ltd. Specifications subject to change without notice.



YDS-USB-1018 V1

**2MP 1018 OmniVision OV2710 M12 Fixed Focus Dual Lens Stereo
USB 2.0 Camera Module**



Top View

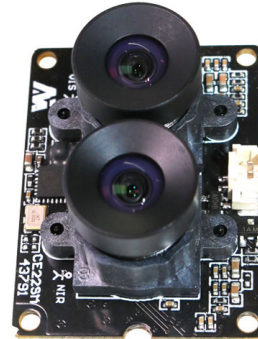

Side View

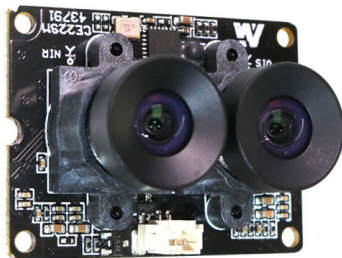

Bottom View



Mating Connector



YDS-USB-1018 V1

2MP 1018 OmniVision OV2710 M12 Fixed Focus Dual Lens Stereo USB 2.0 Camera Module

FORMAT	RESOLUTION	FRAME RATE
		USB 2.0
MJPG	640 x 480 (VGA)	30 FPS
	1280 x 720 (720P)	30 FPS
	1920 x 1080 (1080P)	30 FPS
YUY2	640 x 480 (VGA)	30 FPS
	1280 x 720 (720P)	10 FPS
	1920 x 1080 (1080P)	5 FPS

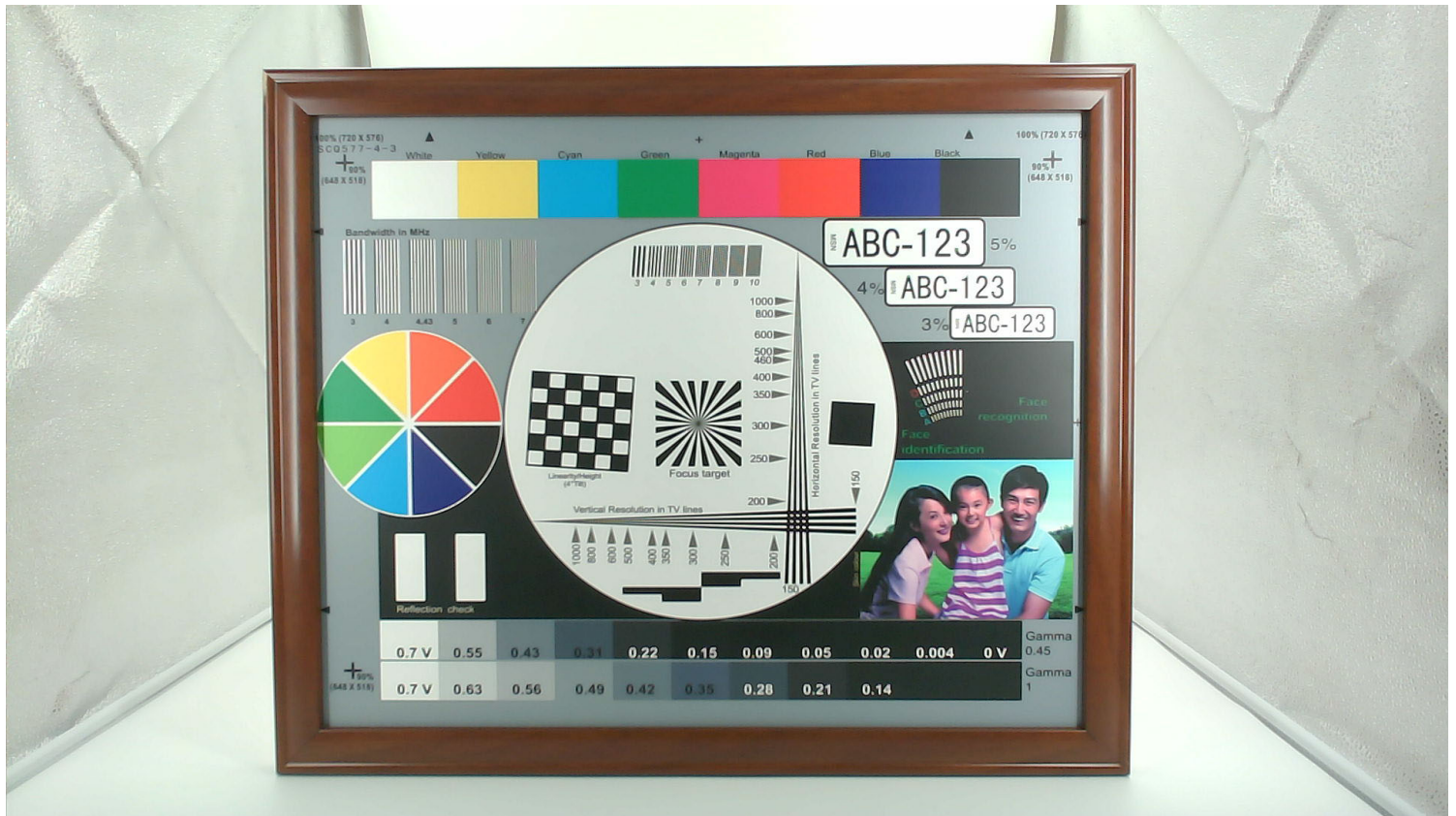



YDS CAMERA MODULE

your best camera partner



www.YDSCAM.com sales@ydscam.com Phone (WeChat, QQ): (+86) 177 2732 6718

All rights reserved @ YingDeShun Co. Ltd. Specifications subject to change without notice.



YDS CAMERA MODULE

your best camera partner



www.YDSCAM.com sales@ydscam.com Phone (WeChat, QQ): (+86) 177 2732 6718

All rights reserved @ YingDeShun Co. Ltd. Specifications subject to change without notice.



YDS CAMERA MODULE

your best camera partner



www.YDSCAM.com sales@ydscam.com Phone (WeChat, QQ): (+86) 177 2732 6718

All rights reserved @ YingDeShun Co. Ltd. Specifications subject to change without notice.



YDS CAMERA MODULE

your best camera partner

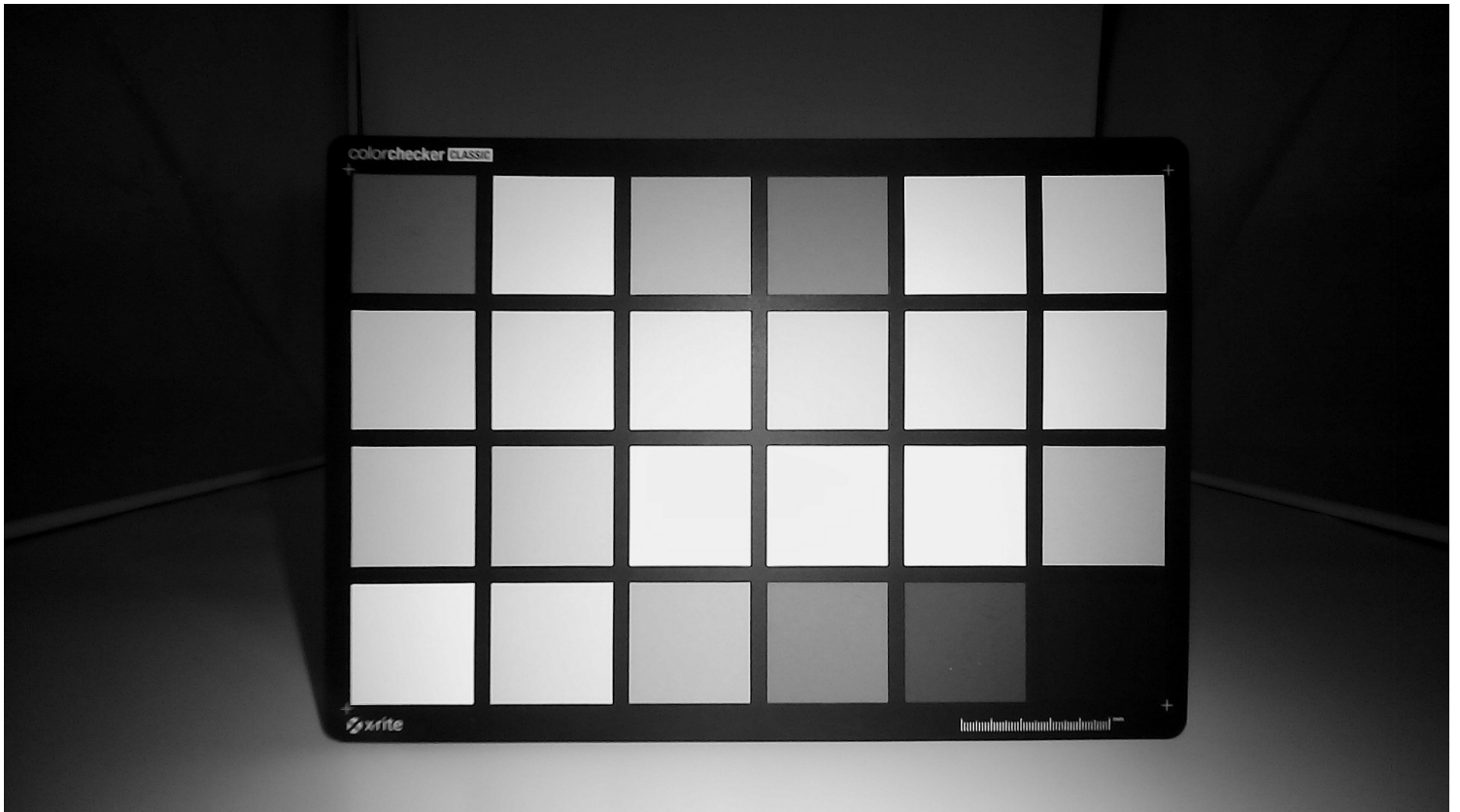

www.YDSCAM.com sales@ydscom.com Phone (WeChat, QQ): (+86) 177 2732 6718

All rights reserved @ YingDeShun Co. Ltd. Specifications subject to change without notice.

Version	Information	Date
V1.0	First Version	8-16-2022

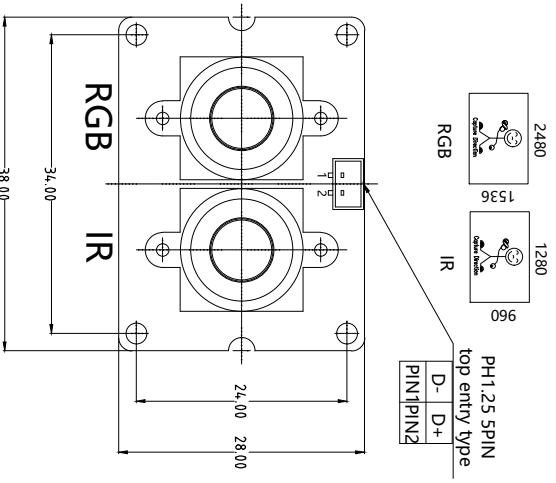

TOP VIEW

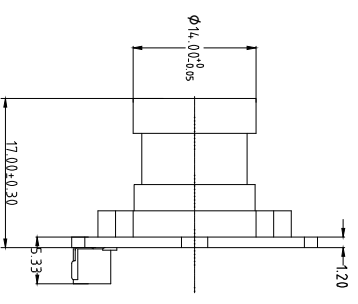

SIDE VIEW

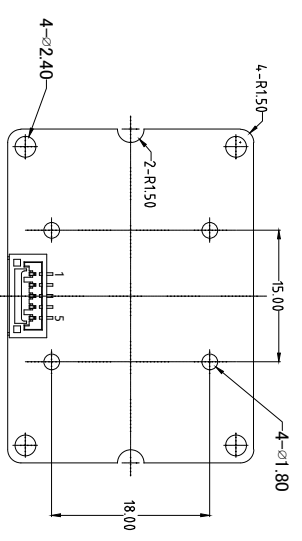

BOTTOM VIEW

Parameters:

- Sensor specification:
 - Image Sensor: TBD
 - Pixel: 2.2umx2.2um,3.75umx3.75um
 - Lens Type: 1/3
 - Important Voltage Description: USB 5V (external power supply);
- Lens specification:
 - FOV: 89°(D);76°(H);60°(V);
 - F/NO: 2.5
 - TV distortion: <0.9%
 - Focal length: 3.0mm
 - Composition: 2P2G+IR FILTER
 - IR Cut Coating: 650nm±10nm@50%

Designed By	Kevin	Model Name:	USB-1018 V1
Checked By	Jacky	Projection Type:	Third Angle
Unit:	mm	Material:	-----
Scale:	1:1	Sheet:	1 of 1
Version:	1/0		

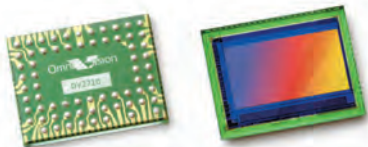

OV2710-1E full HD (1080p) product brief



OmniVision's True 1080p High Definition (HD) Video Image Sensor



available in
a lead-free
package

The OV2710-1E is a true full HD (1080p) CMOS image sensor designed specifically to deliver high-end HD video to digital video camcorders, notebooks, PC webcam, security and other mobile applications. The 1/2.7-inch OV2710-1E addresses the fast growing demand for affordable, HD-quality digital video solutions for video conferencing and recording.

The OV2710-1E is among the very first no-compromise full HD (1080p) sensors available on the market, meaning it offers HD video format with a display resolution of 1920 x 1080 pixels, operating at 30 frames per second. Built with OmniVision's proprietary 3 μm OmniPixel3-HS™ high sensitivity pixel technology, the OV2710-1E delivers low-light sensitivity of 3700 mV/lux-sec, S/N ratio of 40 dB, and

a peak dynamic range of 69 dB, enabling cameras to operate in virtually every lighting condition from bright daylight to nearly complete darkness below 15 lux.

The OV2710-1E supports multiple platform architectures and controllers with both parallel and MIPI interfaces. By allowing system designers to leverage the same opto-electrical design across various products and multiple market segments, the OV2710-1E significantly reduces product development time. OmniVision's OmniPixel3-HS pixel technology has already been proven in high quality webcam/video applications and is now available in 1080p full HD in the OV2710-1E.

Find out more at www.ovt.com.



OmniVision

Applications

- Notebooks
- PC Webcams
- Camcorders
- Security
- Digital Still Cameras
- Telepresence
- Portable Media Players

Product Features

- programmable controls: gain, exposure, frame rate, image size, horizontal mirror, vertical flip, cropping, windowing, and panning
- automatic image control functions:
 - automatic exposure (AEC)
 - automatic gain control (AGC)
 - automatic white balance (AWB)
 - automatic black level calibration (ABLCL)
- serial camera control bus (SCCB)
- lens correction (LENC)
- defect pixel correction (DPC)
- support for digital video port (DVP) parallel output interface
- integrated auto focus filter
- support for one lane MIPI interface (up to 800 Mbps)
- support for 8-/10-bit RAW RGB output format
- support for image sizes:
 - 1080p at 30 fps
 - cropped 720p at 60 fps
 - VGA at 120 fps
- support for black sun cancellation
- embedded one-time programmable (OTP) memory
- on-chip phase lock loop (PLL)
- built-in 1.5V regulator for core

OV2710-1E



Ordering Information

- OV2710-A68A-1E
(color, lead-free, 68-pin CSP3)

Product Specifications

- active array size: 1920 x 1080
- power supply:
 - analog: 3.0 - 3.6V (3.3V typical)
 - core: 1.425 - 1.575V (1.5V typical)
 - I/O: 1.7 - 3.6V (1.8V typical)
- power requirements:
 - active: 350 mW
 - power down: 70 μ A
- temperature range:
 - operating: -30°C to +85°C junction temperature
 - stable image: 0°C to +65°C junction temperature
- output interfaces: 10-bit parallel/one lane MIPI
- output formats: 10-bit RAW RGB
- lens size: 1/2.7"
- lens chief ray angle: 23.6°
- input clock frequency: 6 - 27 MHz
- scan mode: progressive
- maximum image transfer rate:
 - 1080p: 30 fps
 - cropped 720p: 60 fps
 - VGA: 120 fps
 - QVGA: 240 fps
- sensitivity: 3700 mV/lux-sec
- shutter: rolling
- max S/N ratio: 40 dB
- dynamic range: 69 dB @ 8x gain
- maximum exposure interval: 1096 tline
- pixel size: 3 μ m x 3 μ m
- dark current: 20 mV/sec @ 60°C junction temperature
- image area: 5856 μ m x 3276 μ m
- package dimensions: 7465 μ m x 5865 μ m

Functional Block Diagram

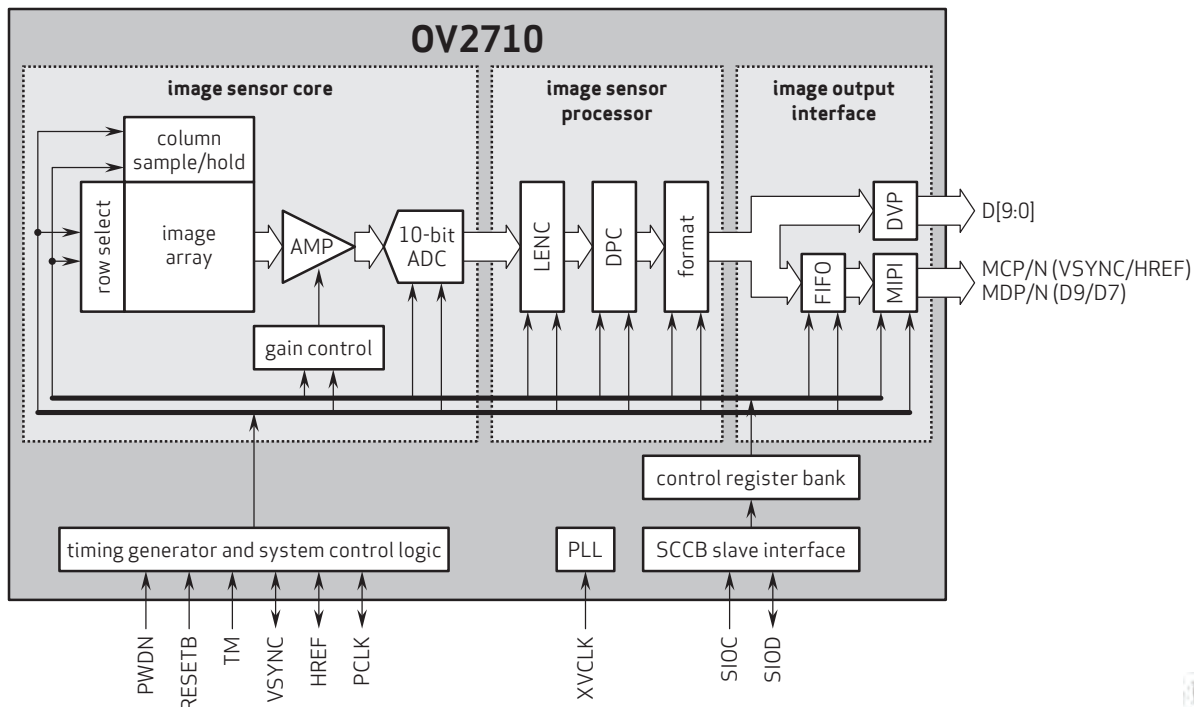

4275 Burton Drive
Santa Clara, CA 95054
USA

Tel: + 1 408 567 3000
Fax: + 1 408 567 3001
www.ovt.com

OmniVision reserves the right to make changes to their products or to discontinue any product or service without further notice. OmniVision, the OmniVision logo and OmniPixel are registered trademarks of OmniVision Technologies, Inc. OmniPixel3-H5 is a trademark of OmniVision Technologies, Inc. All other trademarks are the property of their respective owners.



OmniVision



YDS CAMERA MODULE

your best camera partner

Camera Module Pinout Definition Reference Chart

OmniVision	Sony	Samsung	On-Semi	Aptina	Himax	GalaxyCore	PixArt	SmartSens	Sensors
Pin Signal		Description							
DGND	GND	ground for digital circuit							
AGND		ground for analog circuit							
PCLK	DCK	DVP PCLK output							
XCLR	PWDN	XSHUTDOWN	STANDBY	power down active high with internal pull-down resistor					
MCLK	XVCLK	XCLK	INCK	system input clock					
RESET	RST	reset active low with internal pull-up resistor							
NC	NULL	no connect							
SDA	SIO_D	SIOD	SCCB data						
SCL	SIO_C	SIOC	SCCB input clock						
VSYN	XVS	FSYN	DVP VSYNC output						
HREF	XHS	DVP HREF output							
DOVDD	power for I/O circuit								
AFVDD	power for VCM circuit								
AVDD	power for analog circuit								
DVDD	power for digital circuit								
STROBE	FSTROBE	strobe output							
FSIN	synchronize the VSYNC signal from the other sensor								
SID	SCCB last bit ID input								
ILPWM	mechanical shutter output indicator								
FREX	frame exposure / mechanical shutter								
GPIO	general purpose inputs								
SLASEL	I2C slave address select								
AFEN	CEN chip enable active high on VCM driver IC								
MIPI Interface									
MDN0	DN0	MD0N	DATA_N	DMO1N	MIPI 1st data lane negative output				
MDP0	DP0	MD0P	DATA_P	DMO1P	MIPI 1st data lane positive output				
MDN1	DN1	MD1N	DATA2_N	DMO2N	MIPI 2nd data lane negative output				
MDP1	DP1	MD1P	DATA2_P	DMO2P	MIPI 2nd data lane positive output				
MDN2	DN2	MD2N	DATA3_N	DMO3N	MIPI 3rd data lane negative output				
MDP2	DP2	MD2P	DATA3_P	DMO3P	MIPI 3rd data lane positive output				
MDN3	DN3	MD3N	DATA4_N	DMO4N	MIPI 4th data lane negative output				
MDP3	DP3	MD3P	DATA4_P	DMO4P	MIPI 4th data lane positive output				
MCN	CLKN	CLK_N	DCKN	MIPI clock negative output					
MCP	CLKP	MCP	CLK_P	DCKN	MIPI clock positive output				
DVP Parallel Interface									
D0	DO0	Y0	DVP data output port 0						
D1	DO1	Y1	DVP data output port 1						
D2	DO2	Y2	DVP data output port 2						
D3	DO3	Y3	DVP data output port 3						
D4	DO4	Y4	DVP data output port 4						
D5	DO5	Y5	DVP data output port 5						
D6	DO6	Y6	DVP data output port 6						
D7	DO7	Y7	DVP data output port 7						
D8	DO8	Y8	DVP data output port 8						
D9	DO9	Y9	DVP data output port 9						
D10	DO10	Y10	DVP data output port 10						
D11	DO11	Y11	DVP data output port 11						

www.YDSCAM.com sales@ydscam.com Phone (WeChat, QQ): (+86) 177 2732 6718

All rights reserved @ YingDeShun Co. Ltd. Specifications subject to change without notice.

Cameras Applications



IMAGING DEVICES



Camera Reliability Test

Reliability Inspection Item		Testing Method	Acceptance Criteria	
Category	Item			
Environmental	Storage Temperature	High 60°C 96 Hours	Temperature Chamber	No Abnormal Situation
		Low -20°C 96 Hours	Temperature Chamber	No Abnormal Situation
	Operation Temperature	High 60°C 24 Hours	Temperature Chamber	No Abnormal Situation
		Low -20°C 24 Hours	Temperature Chamber	No Abnormal Situation
	Humidity	60°C 80% 24 Hours	Temperature Chamber	No Abnormal Situation
	Thermal Shock	High 60°C 0.5 Hours Low -20°C 0.5 Hours Cycling in 24 Hours	Temperature Chamber	No Abnormal Situation
Physical	Drop Test (Free Falling)	Without Package 60cm	10 Times on Wood Floor	Electrically Functional
		With Package 60cm	10 Times on Wood Floor	Electrically Functional
	Vibration Test	50Hz X-Axis 2mm 30min	Vibration Table	Electrically Functional
		50Hz Y-Axis 2mm 30min	Vibration Table	Electrically Functional
		50Hz Z-Axis 2mm 30min	Vibration Table	Electrically Functional
	Cable Tensile Strength Test	Loading Weight 4 kg 60 Seconds Cycling in 24 Hours	Tensile Testing Machine	Electrically Functional
Electrical	ESD Test	Contact Discharge 2 KV	ESD Testing Machine	Electrically Functional
		Air Discharge 4 KV	ESD Testing Machine	Electrically Functional
	Aging Test	On/Off 30 Seconds Cycling in 24 Hours	Power Switch	Electrically Functional
	USB Connector	On/Off 250 Times	Plug and Unplug	Electrically Functional



Camera Inspection Standard

Inspection Item		Inspection Method	Standard of Inspection		
Category	Item				
Appearance	FPC/ PCB	Color	The Naked Eye	Major Difference is Not Allowed.	
		Be Torn/Chopped	The Naked Eye	Copper Crack Exposure is Not Allowed.	
		Marking	The Naked Eye	Clear, Recognizable (Within 30cm Distance)	
	Holder	Scratches	The Naked Eye	The Inside Crack Exposure is Not Allowed	
		Gap	The Naked Eye	Meet the Height Standard	
		Screw	The Naked Eye	Make Sure Screws Are Presented (If Any)	
		Damage	The Naked Eye	The Inside Crack Exposure is Not Allowed	
	Lens	Scratch	The Naked Eye	No Effect On Resolution Standard	
		Contamination	The Naked Eye	No Effect On Resolution Standard	
		Oil Film	The Naked Eye	No Effect On Resolution Standard	
		Cover Tape	The Naked Eye	No Issue On Appearance.	
	Function	Image	No Communication	Test Board	Not Allowed
			Bright Pixel	Black Board	Not Allowed In the Image Center
Dark Pixel			White board	Not Allowed In the Image Center	
Blurry			The Naked Eye	Not Allowed	
No Image			The Naked Eye	Not Allowed	
Vertical Line			The Naked Eye	Not Allowed	
Horizontal Line			The Naked Eye	Not Allowed	
Light Leakage			The Naked Eye	Not Allowed	
Blinking Image			The Naked Eye	Not Allowed	
Bruise			Inspection Jig	Not Allowed	
Resolution			Chart	Follows Outgoing Inspection Chart Standard	
Color			The Naked Eye	No Issue	
Noise			The Naked Eye	Not Allowed	
Corner Dark			The Naked Eye	Less Than 100px By 100px	
Color Resolution			The Naked Eye	No Issue	
Dimension	Height	The Naked Eye	Follows Approval Data Sheet		
	Width	The Naked Eye	Follows Approval Data Sheet		
	Length	The Naked Eye	Follows Approval Data Sheet		
	Overall	The Naked Eye	Follows Approval Data Sheet		

YDSCAM Package Solutions

YDS Camera Module



Complete with Lens Protection Film

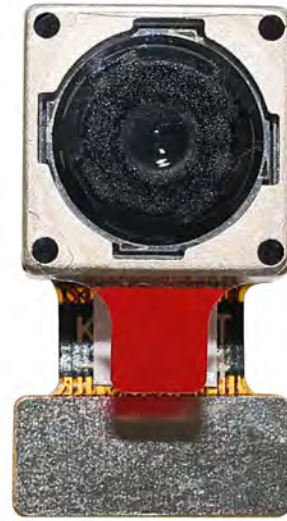

Tray with Grid and Space



Place Cameras on the Tray

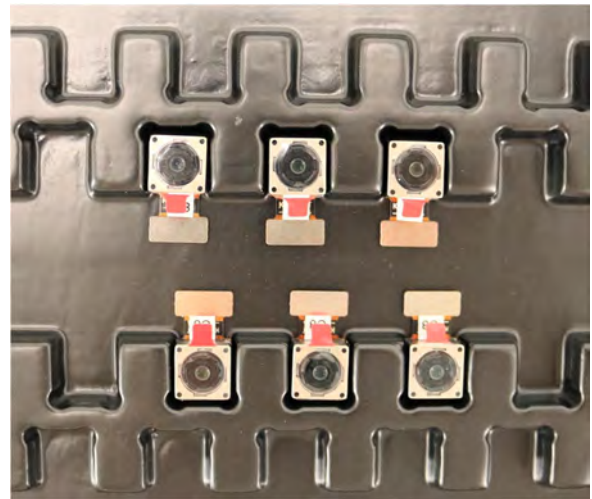

YDSCAM Package Solutions

Full Tray of Cameras

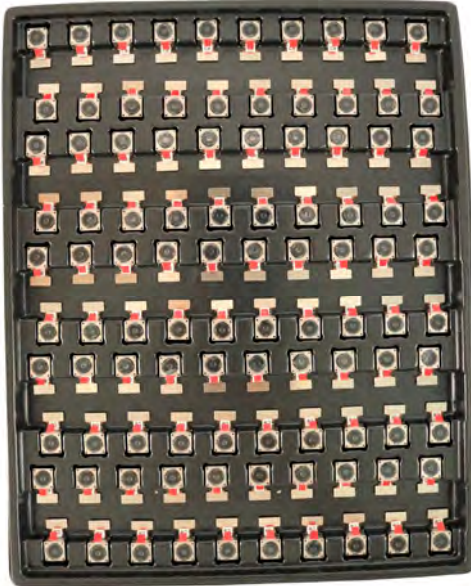

Cover Tray with Lid

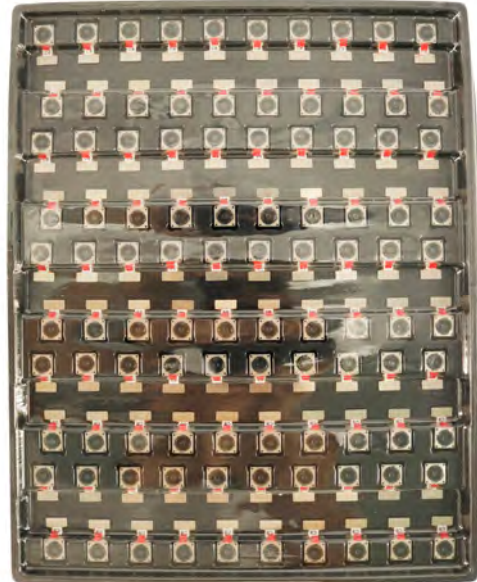

Place Tray into Anti-Static Bag



Vacuum the Anti-Static Bag



YDSCAM Package Solutions

Sealed Vacuum Anti-Static Bag with Labels

1. Model and Description 2. Quantity 3. Manufacturing Date Code 4. Caution



YDSCAM Package Solutions

Place Foam Sheets Between Tray Bags



Foam Sheets are Larger Than Trays



Place Foam Sheets and Trays into Box



Foam Sheets are Tightly Fitting in Box



Seal the Carbon Box



Label the Carbon Shipping Box





YDSCAM Package Solutions

USB Camera Module

Complete with Lens Protection Film

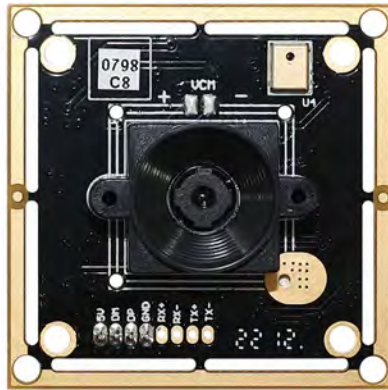

Place Camera Sample into Anti-Static Bag

Place USB Cameras into Tray



Seal the Tray with Anti-Static Bag

Label the Carbon Shipping Box



YDSCAM Package Solutions

Place Camera Sample into Anti-Static Bag



Place Connectors into Anti-Static Bag



Label the Sample Bags



Place Connectors into Reel



Place Samples into the Carbon Box



Place Connectors into the Carbon Box





YDS CAMERA MODULE

your best camera partner

Company YDSCAM

YingDeShun Co. Ltd. (YDS) was established in 2017, a next-generation technology driven manufacturer specialized in research, design, and produce of audio and video products. YDS is occupying 20,000 square feet automated plants with 100 employees of annual throughput 30,000,000 units cameras.

YDS provides OEM, ODM design, contract manufacturing, and builds the camera products. You may provide the requirements to us, even with a hand draft, our sales and engineering work together to meet your needs. We consider ourselves your last-term partner in developing practical and innovative solutions.

Our team covers everything from initial concept development to mass produced product. YDS specializes in customized camera design, raw material, electronic engineering, firmware/software development, product testing, and packing design. Our experienced strategic supply systems offer a robust and dependable manufacturing capacity for orders of various sizes.

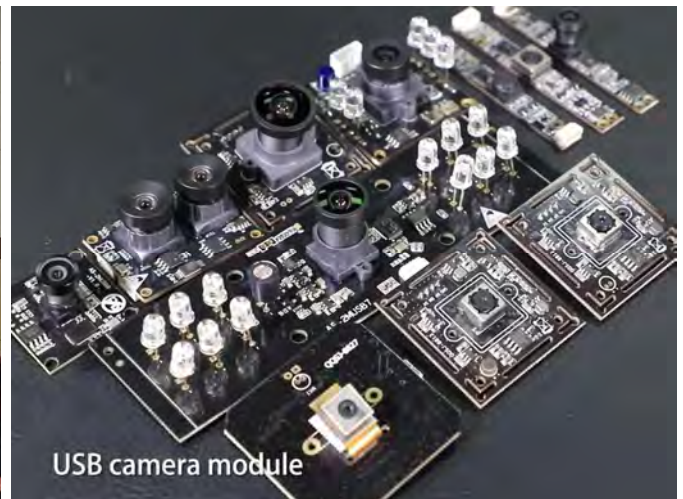

Limited Warranty

YDS provides the following limited warranty if you purchased the Product(s) directly from YDS company or from YDS's website www.YDSCAM.com. Product(s) purchased from other sellers or sources are not covered by this Limited Warranty. YDS guarantees that the Product(s) will be free from defects in materials and workmanship under normal use for a period of one (1) year from the date you receive the product ("Warranty Period").

For all Product(s) that contain or develop material defects in materials or workmanship during the Warranty Period, YDS will, at its sole option, either: (i) repair the Product(s); (ii) replace the Product(s) with a new or refurbished Product(s) (replacement Product(s) being of identical model or functional equivalent); or (iii) provide you a refund of the price you paid for the Product(s).

This Limited Warranty of YDS is solely limited to repair and/or replacement on the terms set forth above. YDS is not reliable or responsible for any subsequent events.



www.YDSCAM.com sales@ydscam.com Phone (WeChat, QQ): (+86) 177 2732 6718

All rights reserved @ YingDeShun Co. Ltd. Specifications subject to change without notice.



YDS CAMERA MODULE

your best camera partner

YDS Strength

Powerful Factory



Professional Service



Promised Delivery



www.YDSCAM.com sales@ydscam.com Phone (WeChat, QQ): (+86) 177 2732 6718

All rights reserved @ YingDeShun Co. Ltd. Specifications subject to change without notice.